

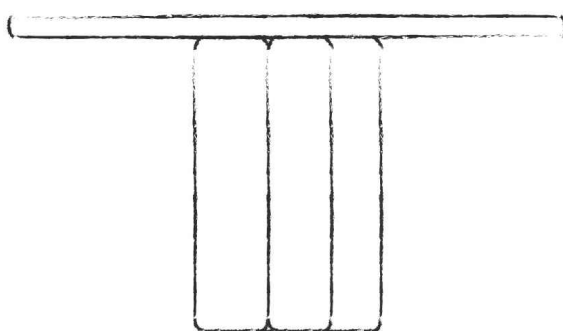

MADE IN ITALY



TAVOLI - KAEL - TABLE

# KAEL Baxter P.



52x55 h 50

Tavolino / Small table

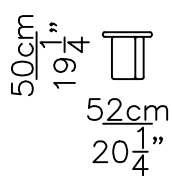

127x137 h 34

Tavolino / Small table

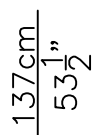
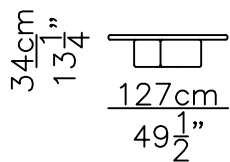
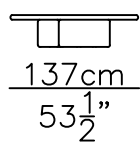

185x99 h 26

Tavolino / Small table

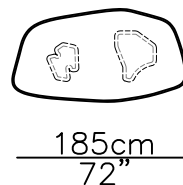
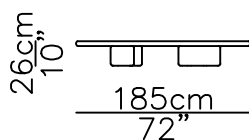
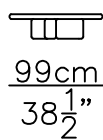

138x142 h 75

Tavolo / Table

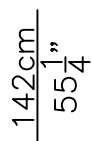
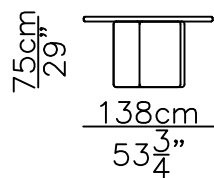
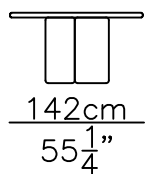

177x180 h 75

Tavolo / Table

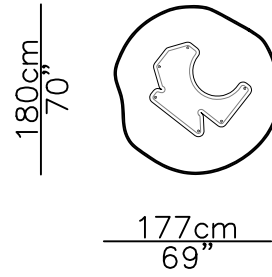
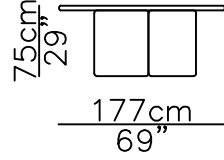
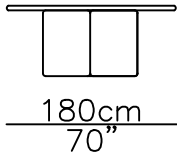

293x176 h 75

Tavolo / Table

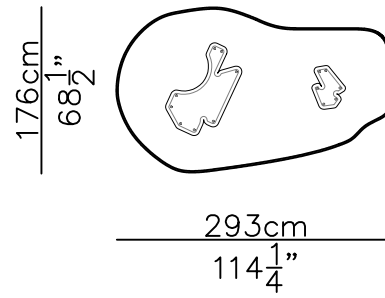
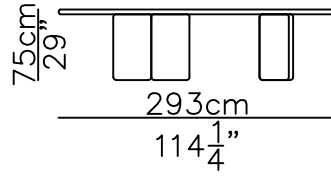
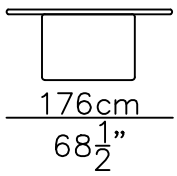

# COMPONENTI / COMPONENTS

## **Versione / Version 52x55 h50 - 127x137 h34- 185x99 h26**

Top e base sono un corpo unico / *The top and base are a single unit*

## **Versione / Version 138x142 h75**

n° 01 - Top / *Top*

n° 01 - Gamba / *Leg*

n° 04 - Viti testa flangiata M8x35mm / *Flange head screws M8x35 mm*

n° 06 - Piedini regolabili h 10mm / *Adjustable feet h 10mm*

## **Versione / Version 177x180 h75**

n° 01 - Top / *Top*

n° 01 - Gamba / *Leg*

n° 04 - Viti testa flangiata M8x35mm / *Flange head screws M8x35 mm*

n° 06 - Piedini regolabili h 10mm / *Adjustable feet h 10mm*

## **Versione / Version 293x176 h75**

n° 01 - Top / *Top*

n° 02 - Gamba / *Leg*

n° 08 - Viti testa flangiata M8x35mm / *Flange head screws M8x35 mm*

n° 14 - Piedini regolabili h 10mm / *Adjustable feet h 10mm*

# 1

Se pavimento è irregolare installare i piedini regolabili forniti.

( Figura 1 - Fase 1 )

*If the floor is uneven, install the supplied adjustable feet. ( Picture 1 - Step 1 )*

Posizionare la gamba e regolare i piedini. ( Figura 2 - Fase 2 )

*Place the base and adjust the feet. ( Picture 2 - Step 2 )*

Posizionare il top sulla base. ( Figura 3 - Fase 3 )

*Place the top on the base. ( Picture 3 - Step 3 )*

Avvitare il top con le viti fornite. ( Figura 4 - Fase 4 )

*Fix the top with the screws provided. ( Picture 4 - Step 4 )*

Verificare la planarità. Se necessario regolare nuovamente i piedini.

( Figura 5 - Fase 5 )

*If needed, adjust the feet to make the table stable.*

*( Picture 5 - Step 5 )*

Montaggio Completato. ( Figura 6 - Fase 6 )

*Assembly completed. ( Picture 6 - Step 6 )*

## Figura 1 - Picture 1

### Fase 1 - Step 1

Vista assonometrica / Isometric view

Se pavimento è irregolare installare i piedini regolabili forniti.  
*If the floor is uneven, install the supplied adjustable feet.*

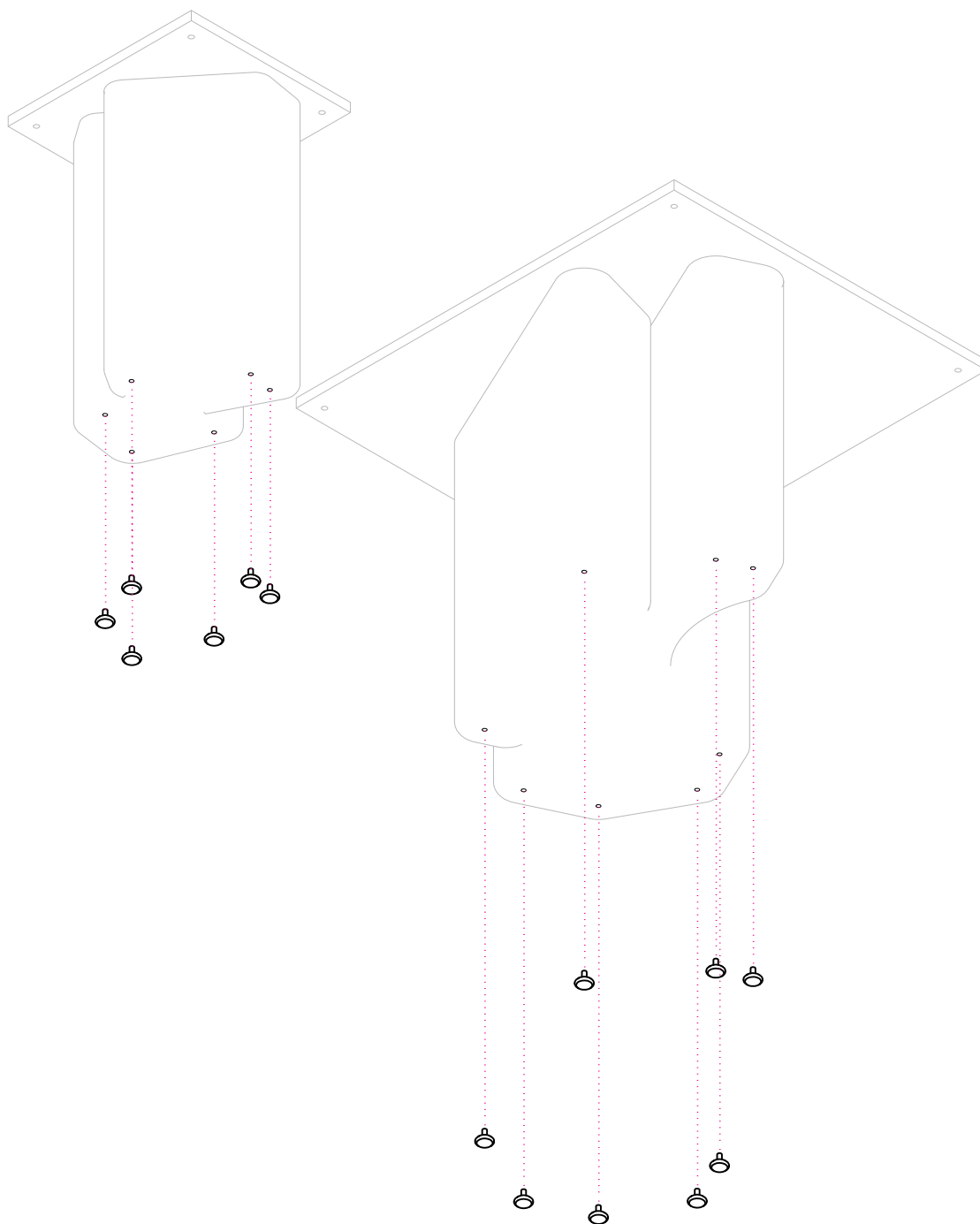

## Figura 2 - Picture 2

### Fase 2 - Step 2

Vista frontale / Front view

Posizionare le gambe e regolare i piedini.  
*Place the base and adjust the feet.*

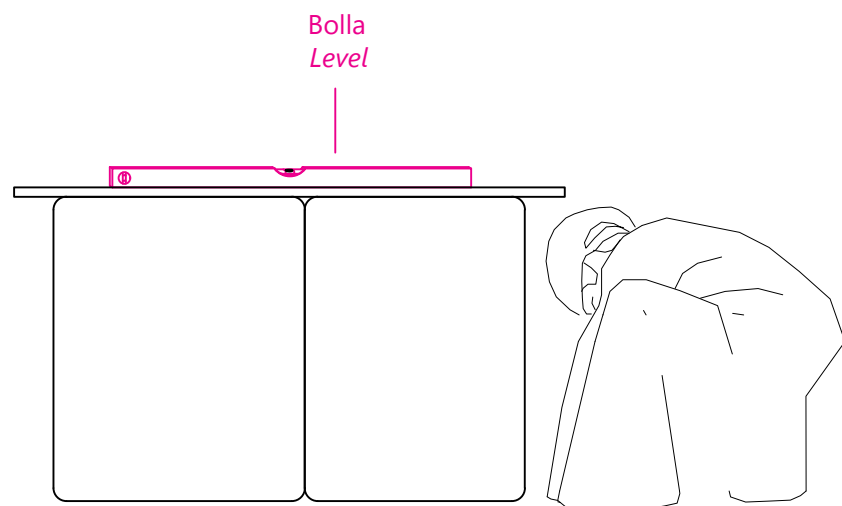

## Figura 3 - Picture 3

### Fase 3 - Step 3

Vista assonometrica / Isometric view

Posizionare il top sulla base.  
*Place the top on the base.*

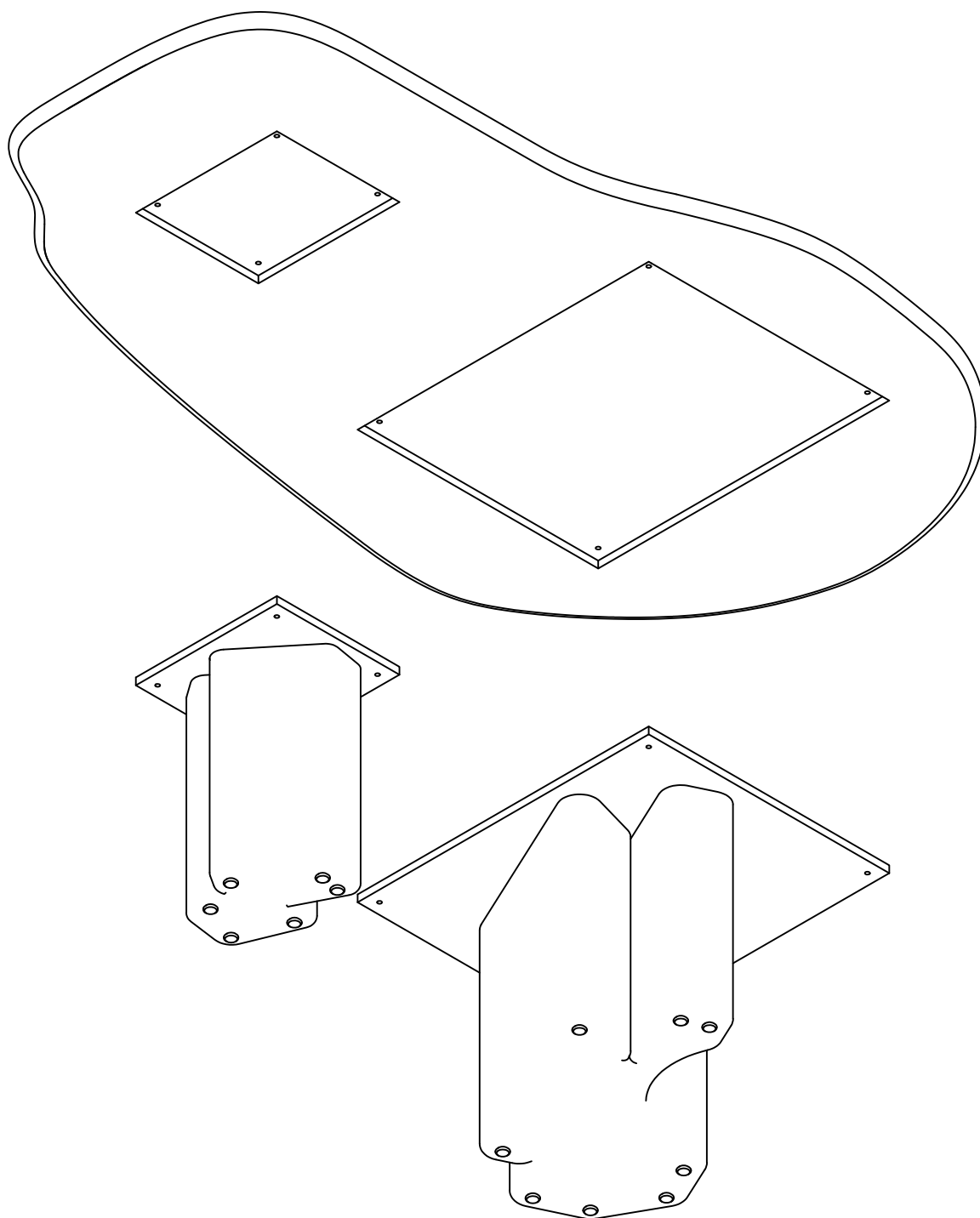

## Figura 4 - Picture 4

### Fase 4 - Step 4

Vista assonometrica / Isometric view

Avvitare il top con le viti fornite.  
Fix the top with the screws provided.

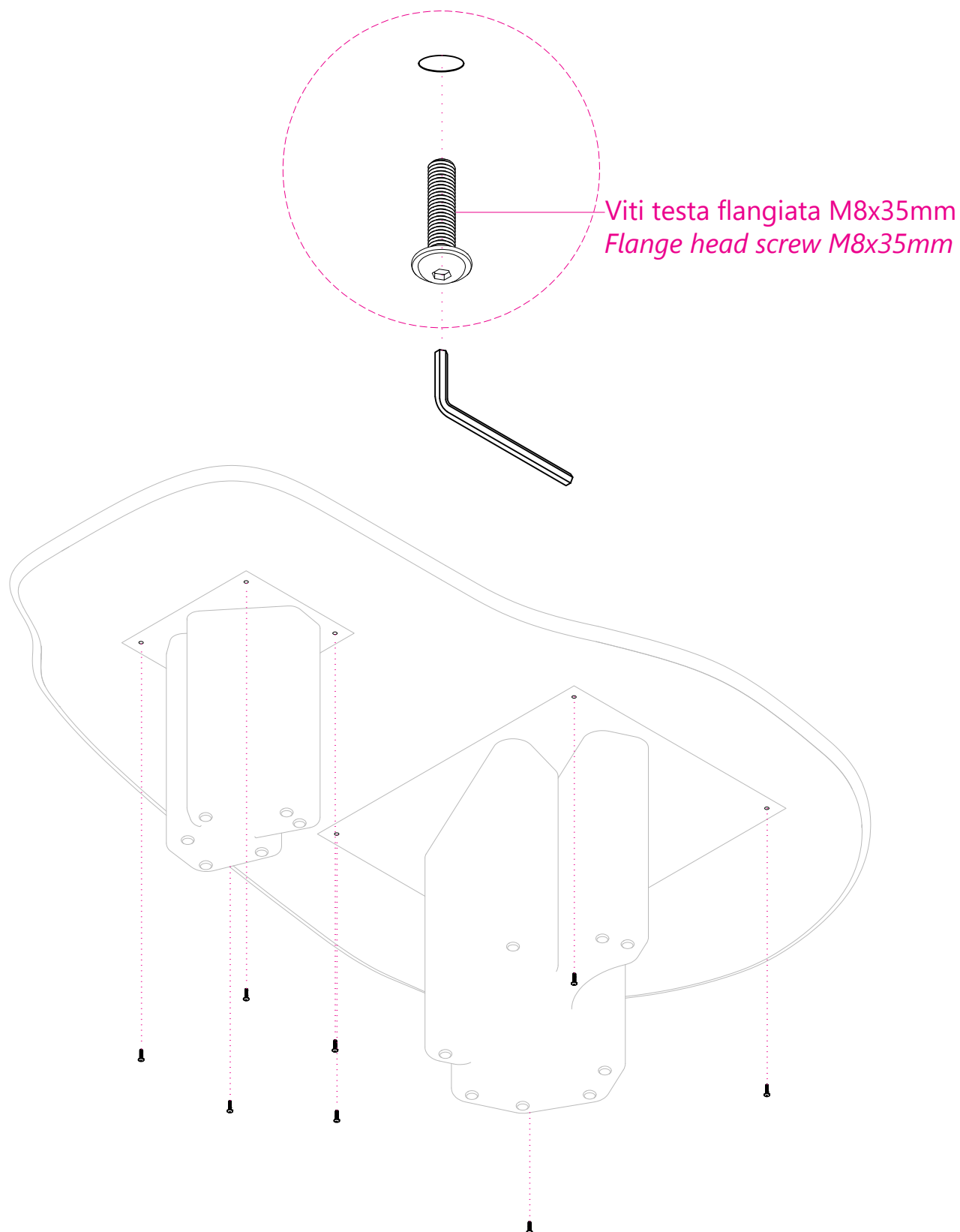

## Figura 5 - Picture 5

### Fase 5 - Step 5

Vista frontale / Front view

Verificare planarità. Se necessario regolare nuovamente i piedini.  
*If needed, adjust the feet to make the table stable.*

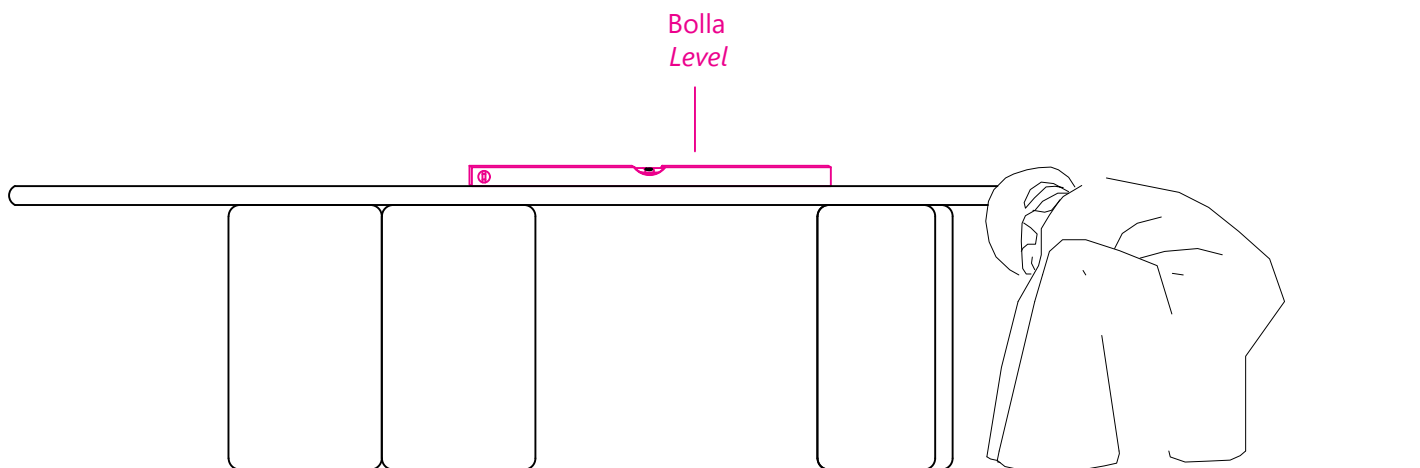

## Figura 6 - *Picture 6*

### Fase 6 - *Step 6*

Vista frontale / *Front view*

Montaggio completato.  
*Assembly completed.*

